

WAP10-25 Case Packer Range

➤ The Fibre King Intermittent Motion Case Packer is an extremely versatile, compact and robust machine.

Designed to accommodate a wide range of pack styles and case configurations for any industry, a sophisticated drive mechanism enables production rates of up to 25 cases per minute and quick, repeatable changeovers. The WAP10-25 Case Packer range will give you clean and accurately squared cases, every time.

At Fibre King, we don't just build machines – we engineer peace of mind. Call us on +61 7 3889 4400 to see how we can help you.

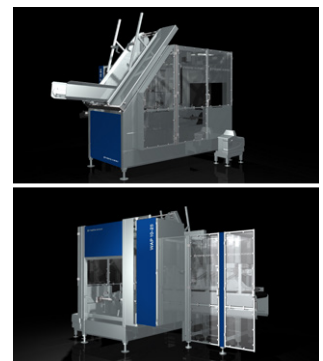

WAP10-25 Features

Fully Automatic Operation

Maximum operating speed **20–25 cases per minute**, infeed/collation dependent.

Heavy Duty Construction

Our case packers are designed for use in 24 hour per day production environments, for a serviceable life of in excess of 15 years.

304 Stainless Steel

Frames and sheet metal as standard, 316 stainless steel is available as an option for highly corrosive products or cleaning agents.

Quick Changeover Times

Changeovers are fast and repeatable. Motorised changeover of major components is available as an option. Ideal for multi-product lines with typical changeover times of less than 20 minutes.

Colour Touchscreen

With full monitoring of machine status and diagnostics. Internet access enables our engineers to provide exceptional levels of remote support.

Quiet Operation

Usually less than 80dB.

Clean and Open Design

With **no product catch points** and easy operator and maintenance access.

Reliability and Spare Parts Availability

Only high-end proprietary items are used, ensuring reliable performance and immediate availability of spare parts.

Accommodation for Multiple Case Styles

Wraparound, trays and shelf-ready presentations.

Compact Footprint

Maximum utilisation of valuable floor space.

Stainless Steel

304 stainless steel frames and sheet metal as standard, 316 stainless steel is available as an option.

Infeed Conveyor

Touch Screen/PLC

Advanced control system with remote access and diagnostics.

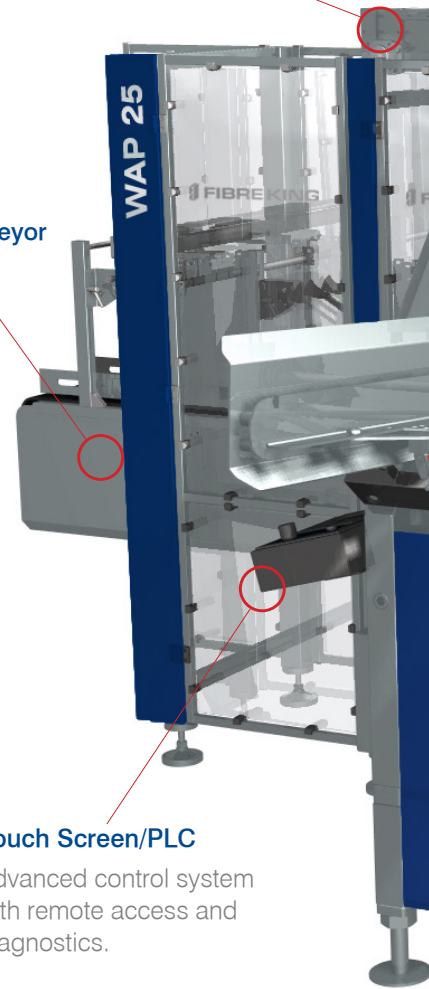

Case Types

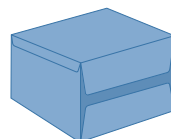

Wraparound case

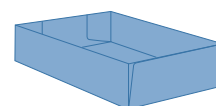

Tray

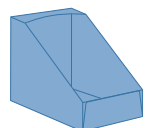

Shelf Ready

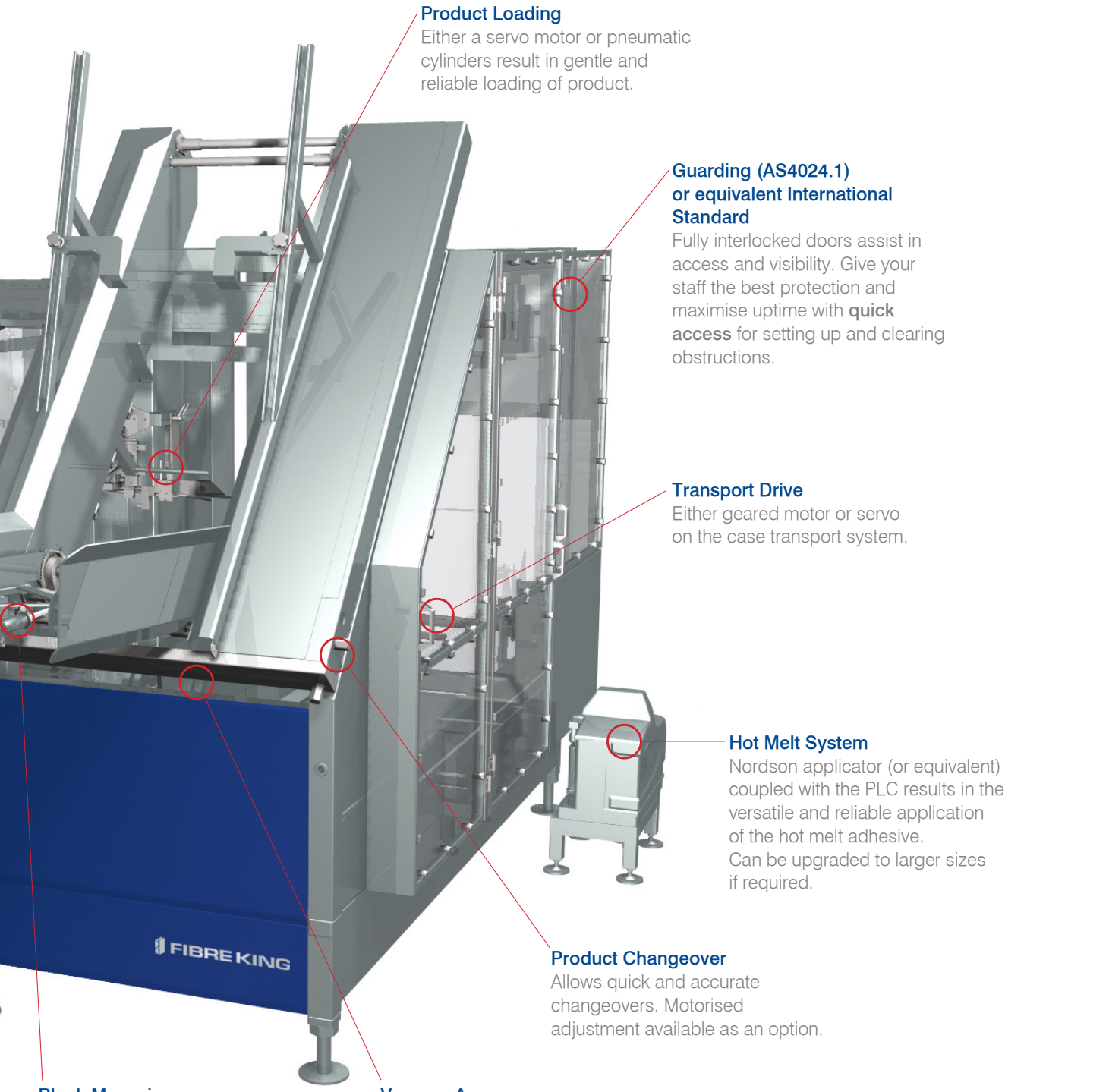

Product Loading

Either a servo motor or pneumatic cylinders result in gentle and reliable loading of product.

Guarding (AS4024.1) or equivalent International Standard

Fully interlocked doors assist in access and visibility. Give your staff the best protection and maximise uptime with **quick access** for setting up and clearing obstructions.

Transport Drive

Either geared motor or servo on the case transport system.

Hot Melt System

Nordson applicator (or equivalent) coupled with the PLC results in the versatile and reliable application of the hot melt adhesive. Can be upgraded to larger sizes if required.

Product Changeover

Allows quick and accurate changeovers. Motorised adjustment available as an option.

Vacuum Arms

Either pneumatic or motor driven.

Blank Magazine

Standard capacity (150–200 blanks) or high capacity (350–400 blanks as shown) depending on layout and production requirements.



Variations and Options

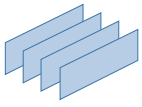

Multi-Lane Feed

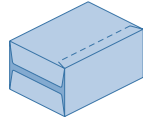

Internal Manufacturer's Flap

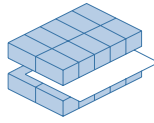

Layer Pad Insertion

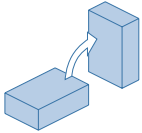

Product Inverter

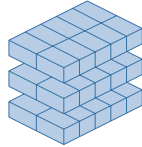

Multi-Layer Stacking

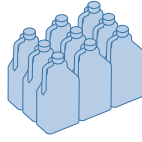

Non-Round Product

The Fibre King Difference

> More Uptime

Fibre King machines are designed and manufactured to withstand constant, rigorous use. Changeovers happen quickly and seamlessly; and we build in easy access for maintenance and upgrades. Our remote monitoring, PLC programming and service standards are such that some of the world's biggest companies choose Fibre King as their preferred supplier.

> Lower Overall Cost of Use

Let's start with strategic design – we make a study of the end use and create a machine that does what it needs to most efficiently, using the best technology available. Our classic Fibre King machines are tailored to your exact requirements, and the beauty is that if your requirements change, the equipment can usually be converted to suit. Less operator intervention is required on a Fibre King machine; your products will be better protected in transit because of our superior quality packs; and all this is backed by faster maintenance and support, plus competitively priced spares.

> 'No Excuses' Service

We stand by our word, and move heaven and earth to make it happen.



(Head Office)

9 Oasis Court, PO Box 3051 Clontarf DC

Q 4019 Australia

t. +61 7 3889 4400 f. +61 7 3889 5255

e. sales@fibreking.com w. fibreking.com



Oryx Automation | A Division of Fibre King Pty Ltd

Hemaraj Eastern Seaboard Industrial Estate

500/98 (ZONE D44) Soi.H1/6 Moo 3 T.Ta-Sit A.Pluak Daeng Rayong 21140

t. +66 38 950 568 - 71 f. +66 38 950 572

e. sales@oryxautomation.com w. oryxautomation.com

